

MyBabiie®

For little people who dream big

MB200i Travel System Instructions



IMPORTANT! KEEP FOR FUTURE REFERENCE

Get to know your MB200i Travel System

Scan the QR code below on your camera app to be linked off to our page to get all the information you need for using your MB200i Travel System. From setting it up to how to fold it down, it's all there!



SCAN ME



1

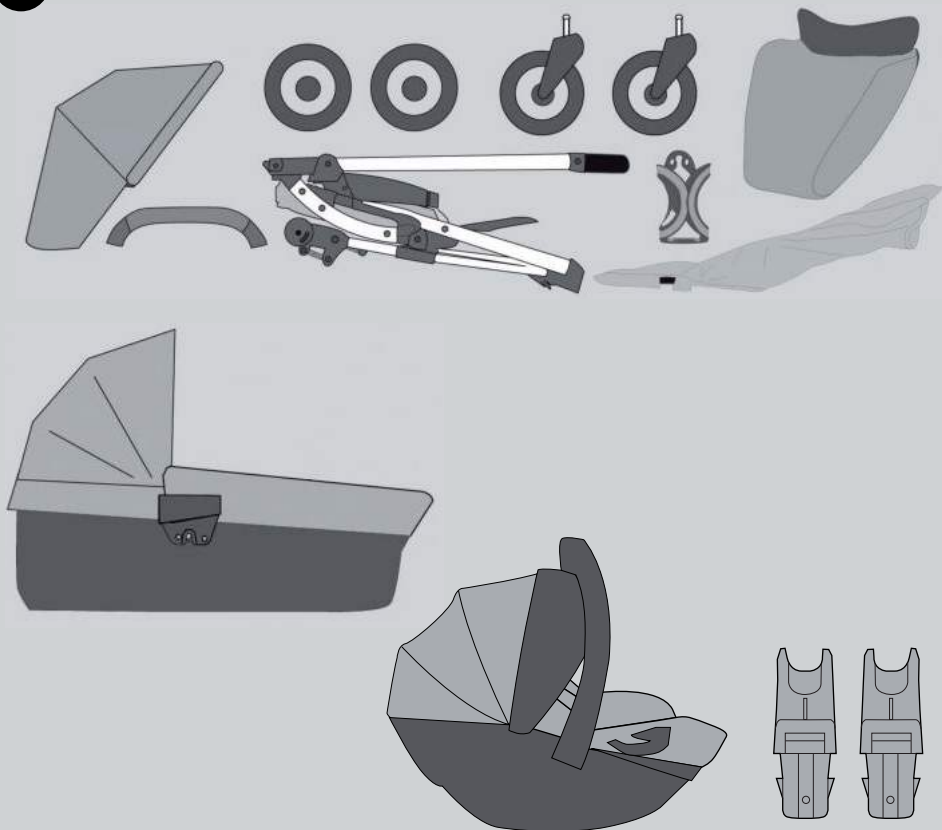

2a

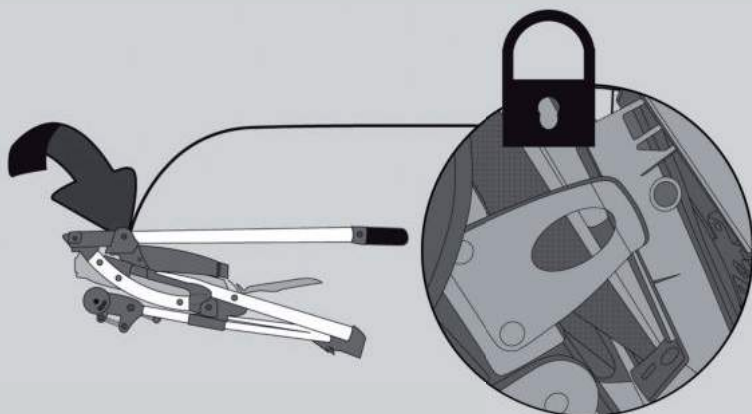

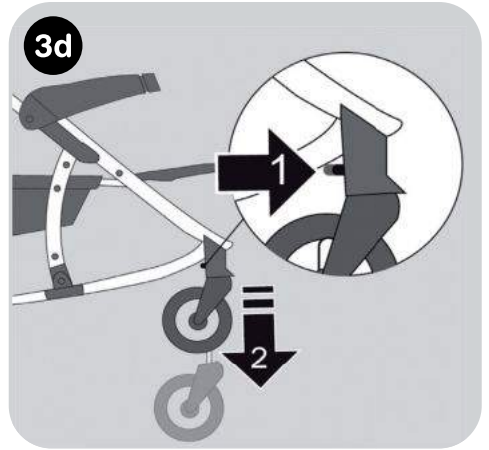
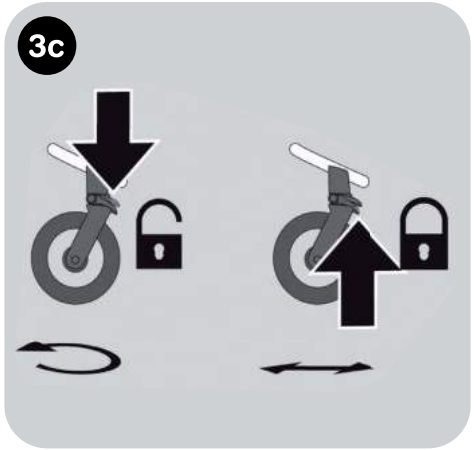
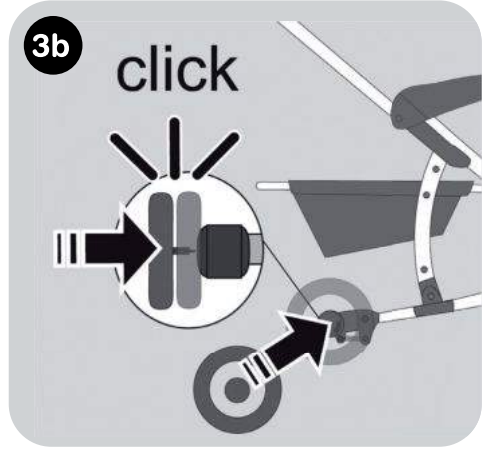
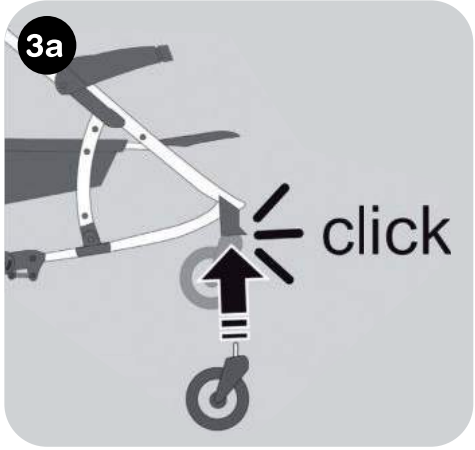

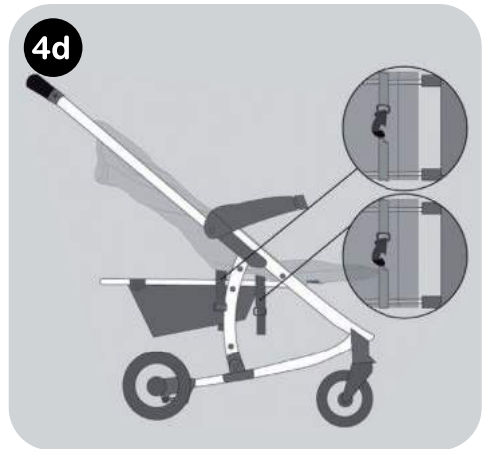
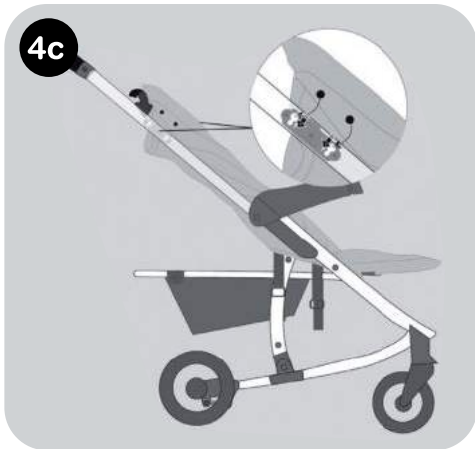
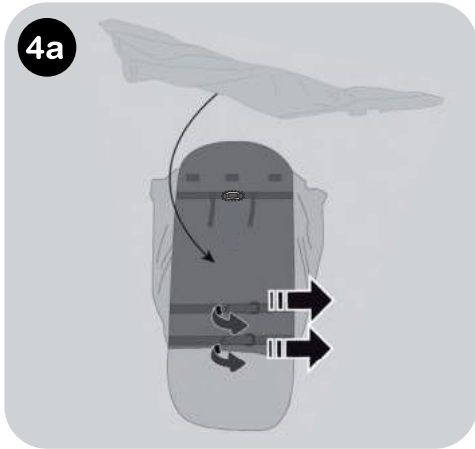
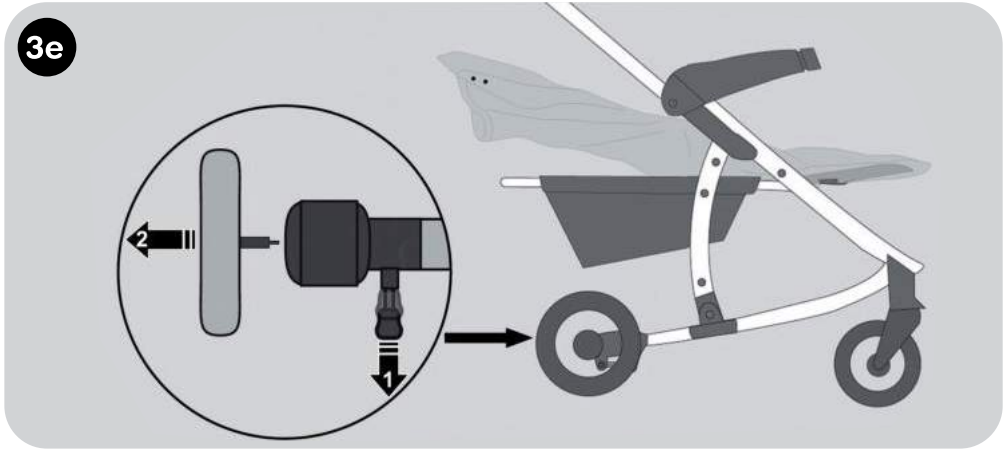

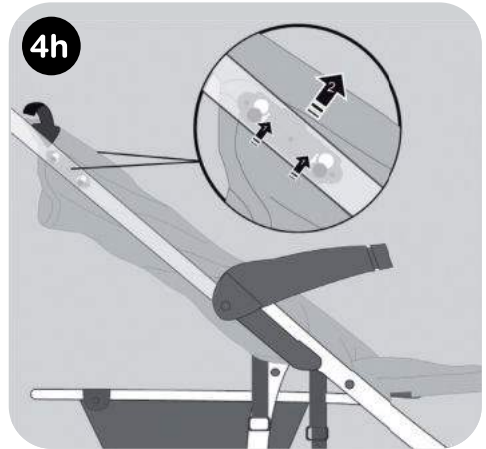
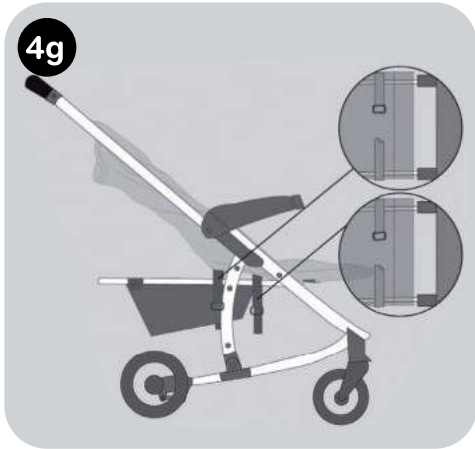
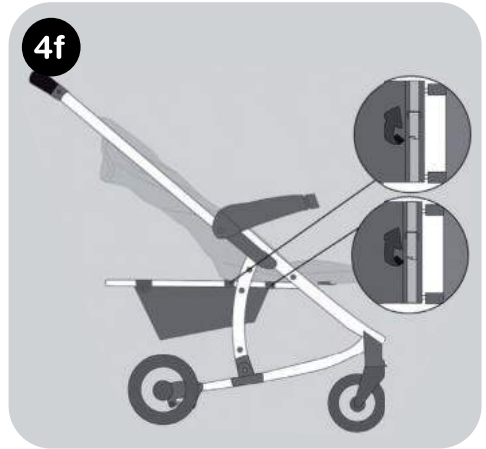
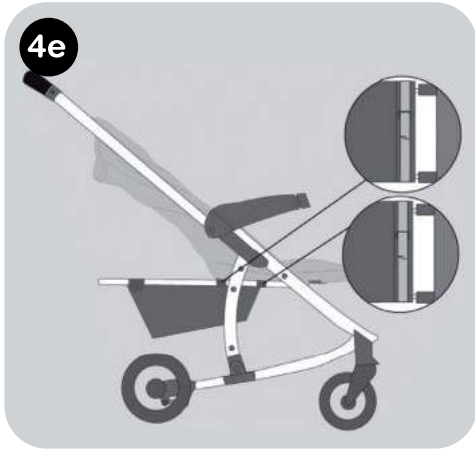

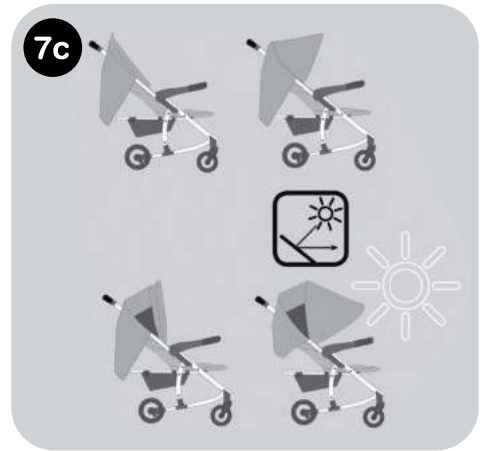
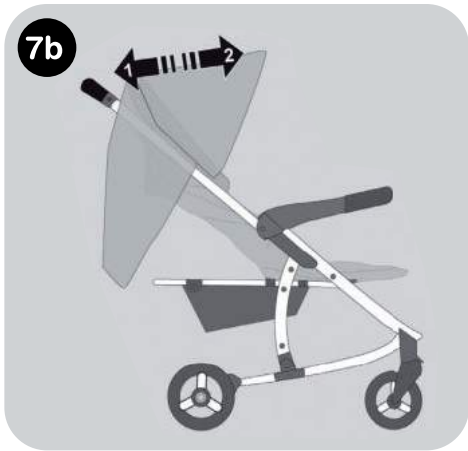
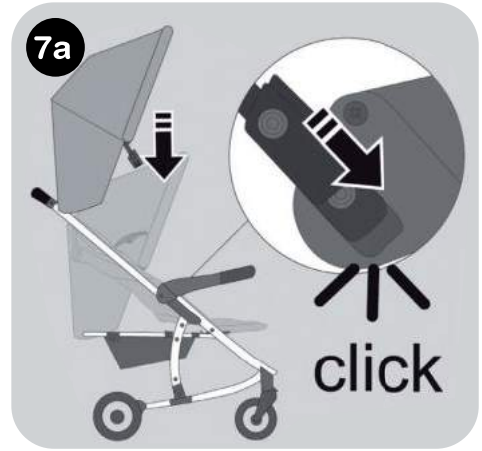
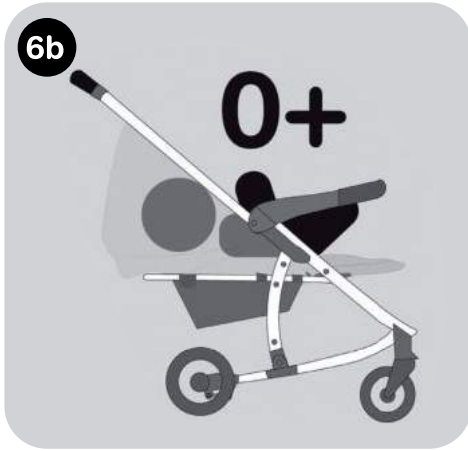
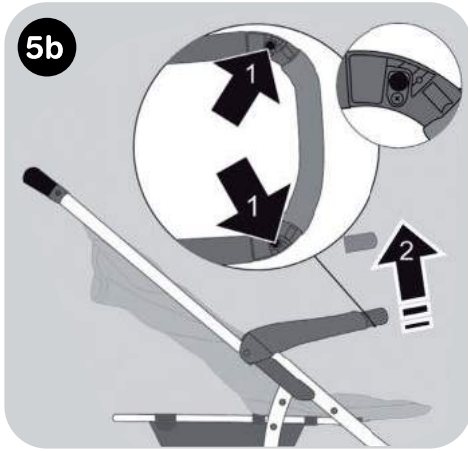

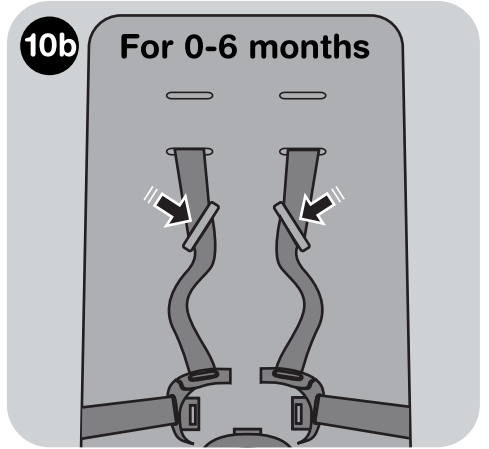
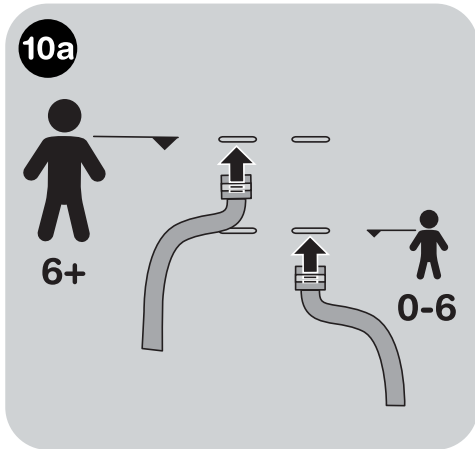
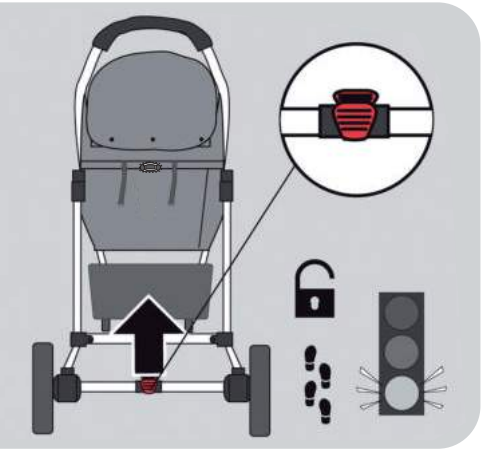
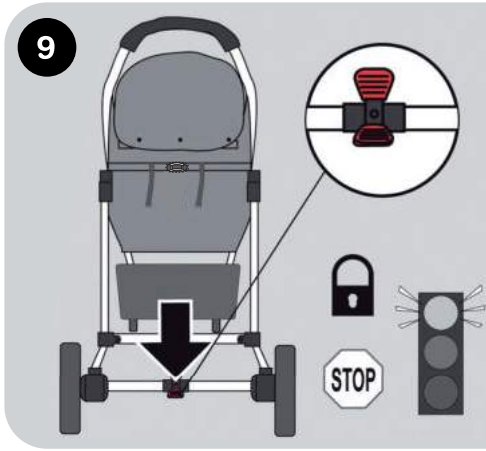
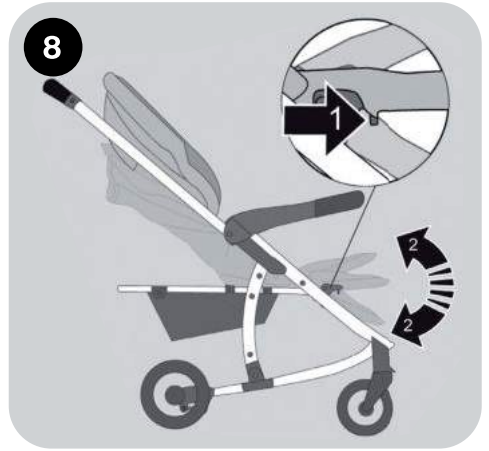

10c

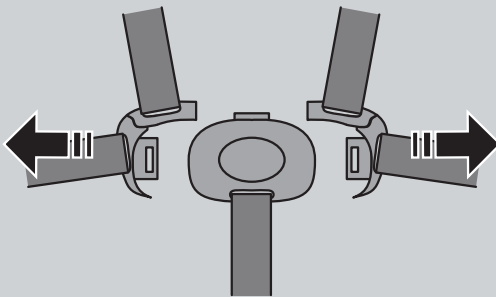
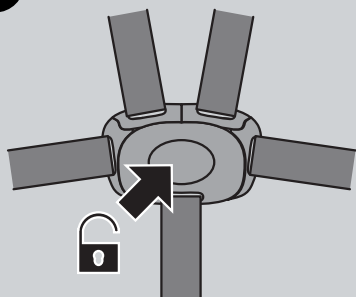

Option

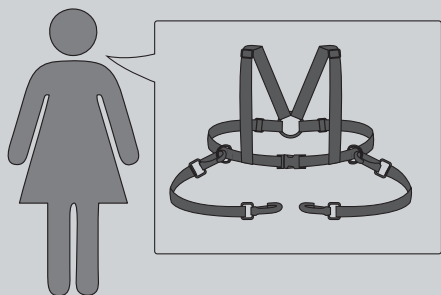

Option 1

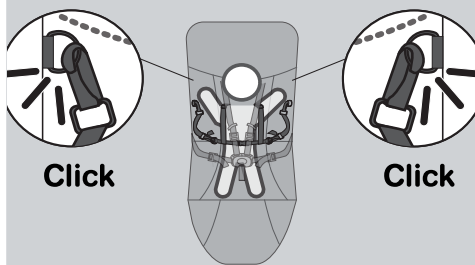

11a

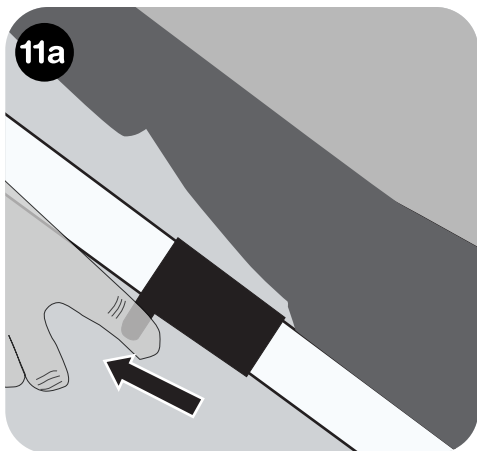

11b



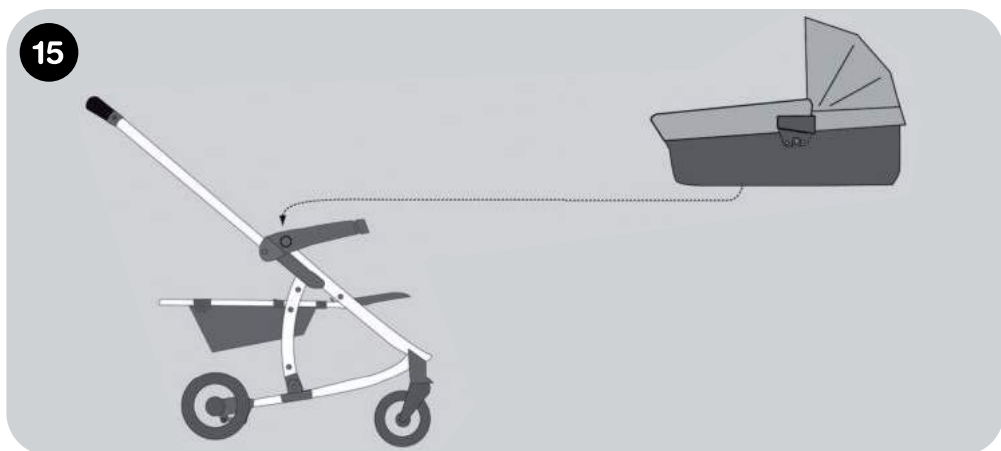
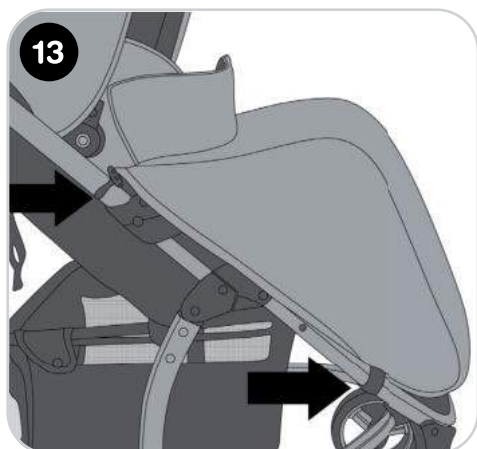
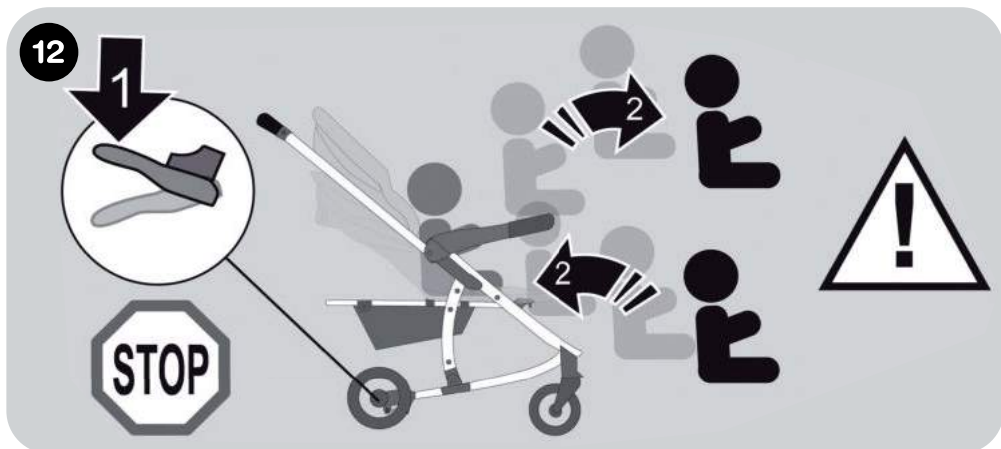

16a

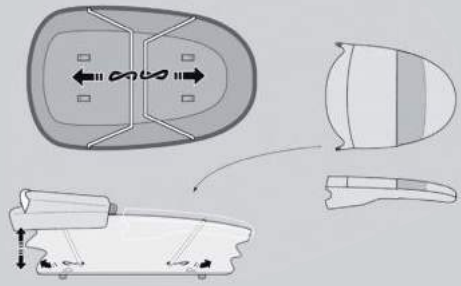

16b

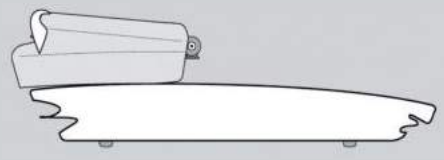

16c

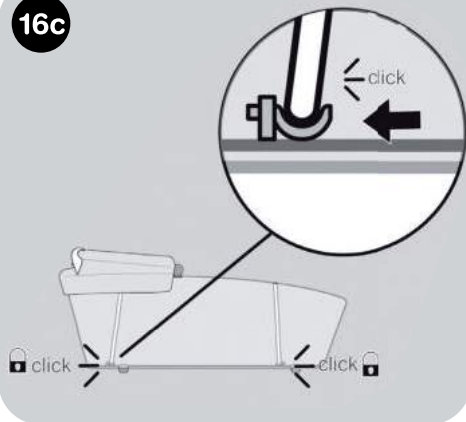

16d



17

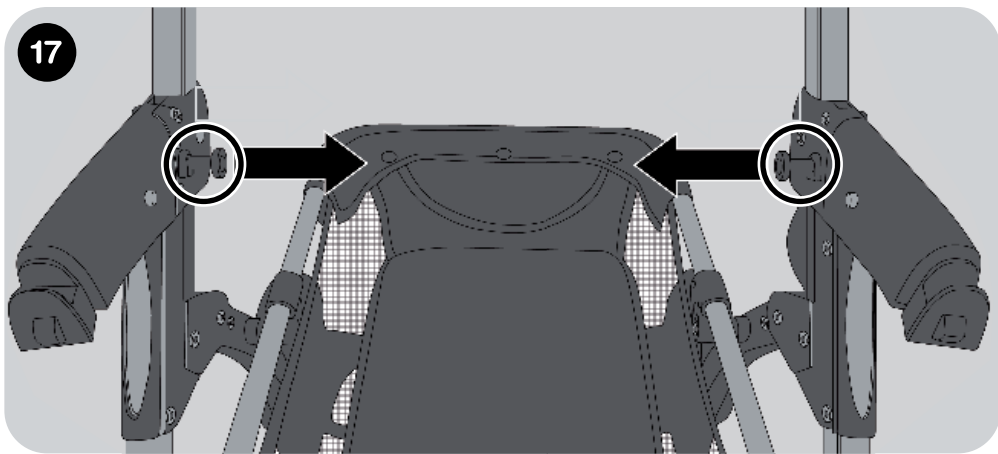

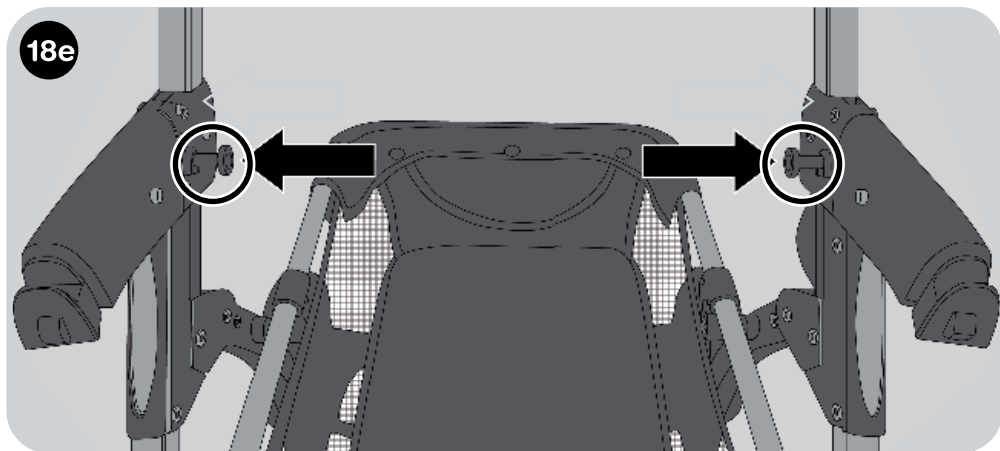
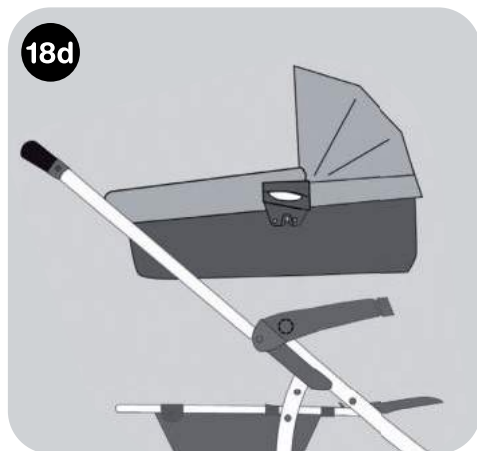
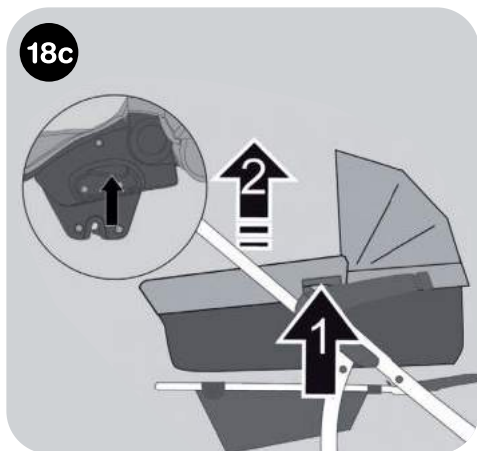
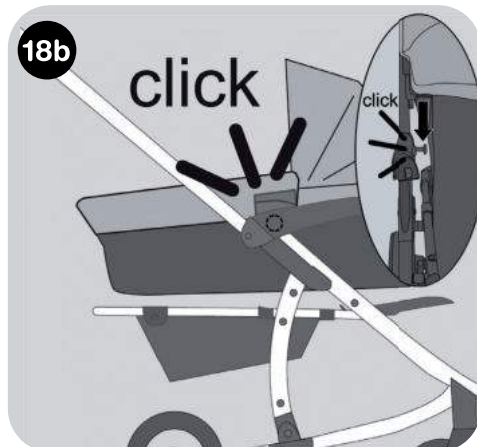
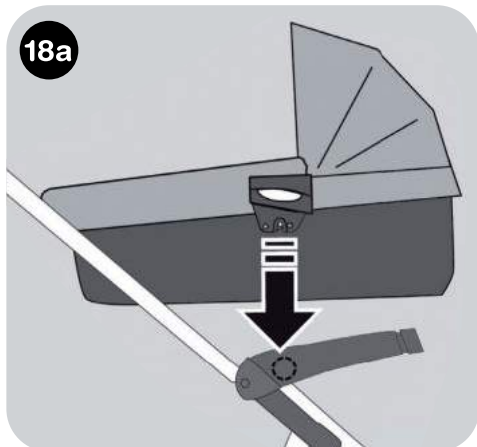

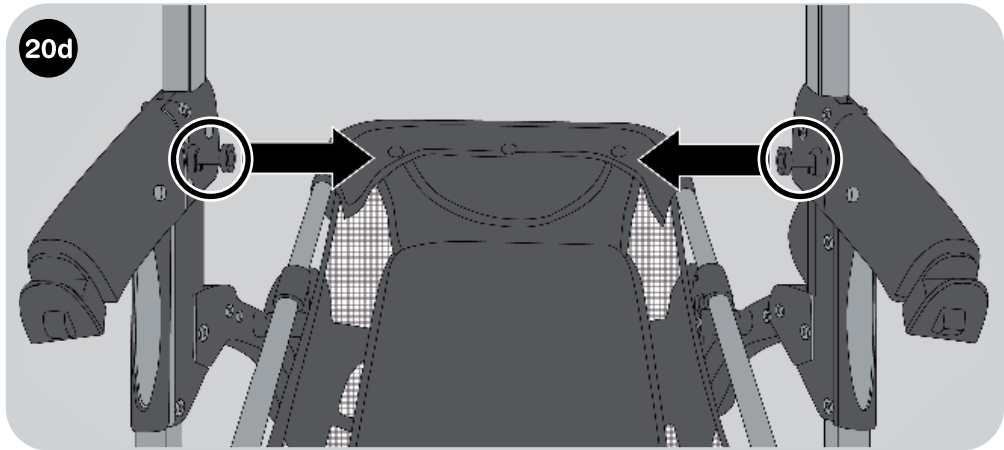
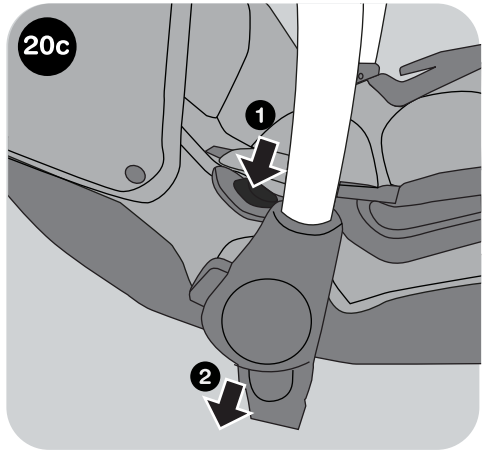
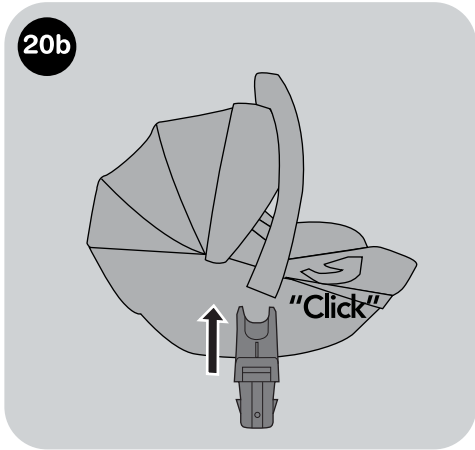
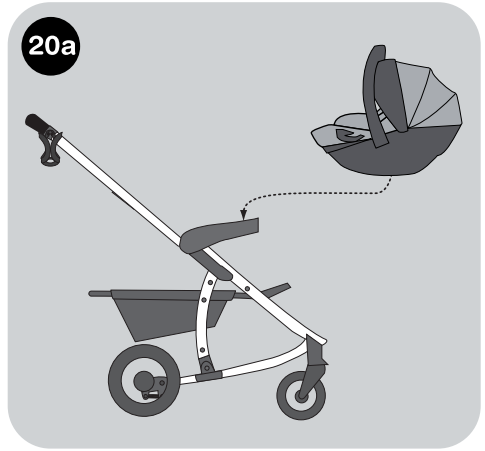
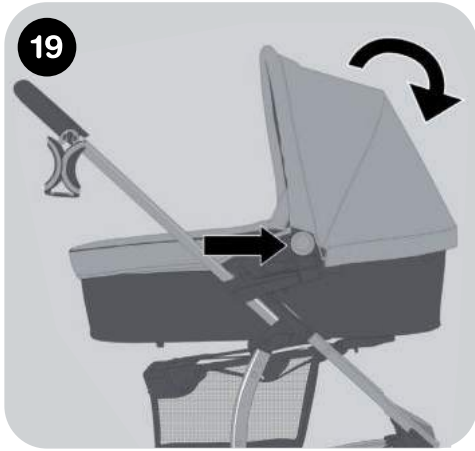

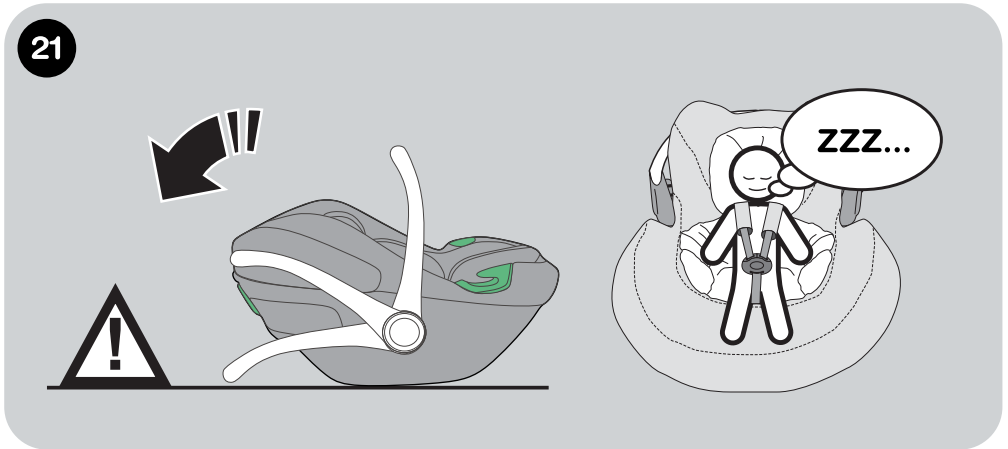
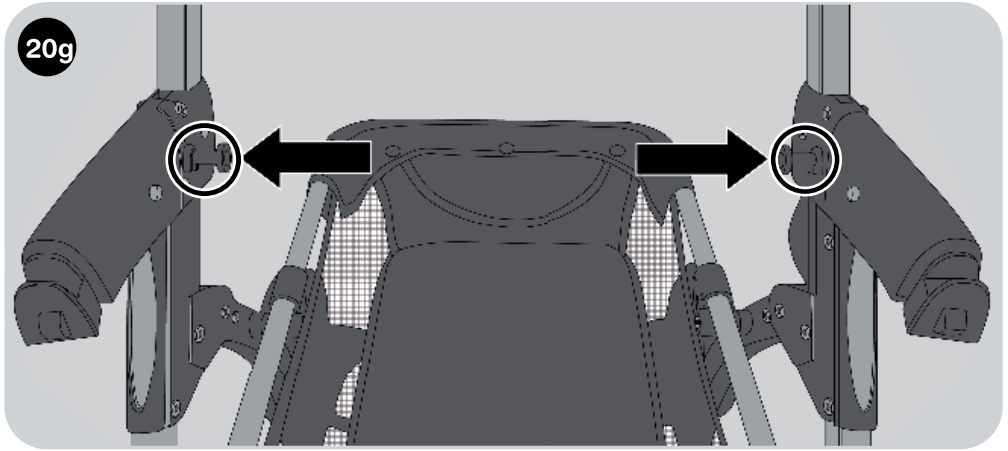
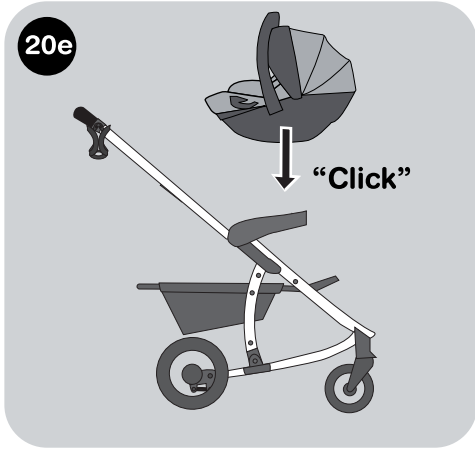

SAFETY & CARE INFORMATION

IMPORTANT, RETAIN FOR FUTURE REFERENCE: READ CAREFULLY

Please read these instructions carefully before use and keep them for later reference.

Remove all packaging and non-permanent labels and dispose of safely before using this product. The safety of your child could be put at risk if you do not follow these instructions.

This stroller is designed for 1 child from 0 months up to a weight of 22 kg/36 months.

WARNING: Never leave your child unattended.

WARNING: Uneven or excessive loading of items on or in the stroller may cause the product to tip and may cause injury.

WARNING: Maximum intended weight within the shopping basket is 3kg.

WARNING: Ensure that all the locking devices are engaged before use.

WARNING: To avoid injury ensure that your child is kept away when unfolding and folding this stroller.

WARNING: Do not let your child play with this stroller.

WARNING: Always use the restraint system.

WARNING: Check that the pram body or seat attachment devices are correctly engaged before use.

WARNING: Do not put hot drinks or liquids in the cup holder.

WARNING: This product is not suitable for running or skating.

WARNING: Do not insert any additional mattresses into the stroller.

WARNING: Accessories which are not approved by the manufacturer shall not be used.

WARNING: This pushchair has been designed for one child and shall be used for the transport for only one child!

WARNING: Always use the crotch strap in combination with the waist belt.

WARNING: This stroller does not replace a cot or a bed. Should your child need to sleep, then it should be placed in a suitable cot or bed.

WARNING: Only replacement parts supplied or recommended by My Babiie shall be used.

WARNING: Any load attached to the handle and on the back of the backrest and on the sides of the stroller will affect the stability of the stroller.

WARNING: The parking device shall be engaged when placing and removing the children.

WARNING: The carrycot should not be used as soon as the child is able to sit by themselves, roll over or can push itself up on its hands and knees. Maximum weight of the child: 9kg

EN1888-1&2:2018

SAFETY & CARE INFORMATION

Care and Maintenance

- Please check on a regular basis that the brakes, wheels, latches, connecting elements, belt systems and seams are properly functional.
- Do not expose the stroller to strong sunshine.
- Sponge clean only.
- After use in rain or snow, the wheels should be lubricated and the stroller dried to prevent rust.
- Care for, clean and check this stroller regularly.
- Do not use accessories that have not been approved by the manufacturer.

Your child's safety is your responsibility

If you have a problem with this product or require replacement parts, please visit www.mybabiie.com/support

Register your product at: www.mybabiie.com/warranties

CAR SEAT NOTICE

This is an i-Size Enhanced Child Restraint System. It is approved according to UN Regulation No.129, for use in i-Size compatible vehicle seating positions as indicated by vehicle manufacturers in the vehicle users' manual.

If in doubt, consult either the Enhanced Child Restraint System manufacturer or the retailer.

Do not use the ECRS in seating positions where there is an active frontal airbag installed.

CAR SEAT WARNING

- For infants of height ranges from 40cm to 87cm. The weight of the child should be less than or equal to 13kg.
- The rigid items and plastic parts of an Enhanced Child Restraint System shall be so located and installed that they are not liable, during everyday use of the vehicle, to become trapped by a movable seat or in a door of the vehicle.
- Do use carry-cots perpendicular to the longitudinal axis of the vehicle.
- Any straps holding the restraint to the vehicle should be tight, any support-leg should be in contact with the vehicle floor, any straps or impact shields restraining the child should be adjusted to the child's body and straps should not be twisted.
- It is important to ensure that any lap strap is worn low down.
- The Enhanced Child Restraint System should be replaced when it has been subject to violent stresses in an accident.
- It is dangerous to make any alterations or additions to the device without the approval of the Type Approval Authority, and it is also dangerous if you do not follow closely the installation instructions provided by the Enhanced Child Restraint System manufacturer.
- Be sure that children are not left in their ECRS unattended.
- Be sure that any luggage or other objects liable to cause injuries in the event of a collision are properly secured in the vehicle.
- Be sure that the Enhanced Child Restraint System shall not be used without the cover.
- Be sure that the Enhanced Child Restraint System cover is not replaced with any other than the one recommended by the manufacturer because the cover constitutes an integral part of the restraint performance.
- Refer to the vehicle manufacturer's handbook for the use of an "i-Size ECRS".

KNOW YOUR INFANT CARRIER

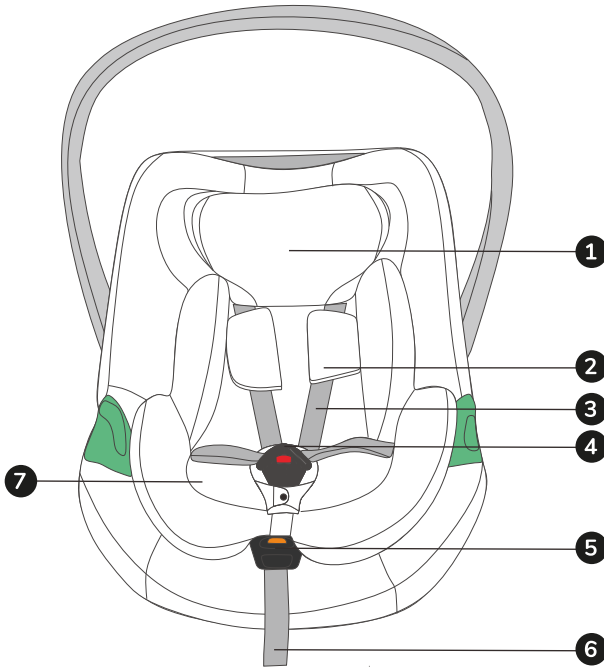

1. Headrest
2. Shoulder pad
3. Shoulder strap
4. Harness buckle
5. Harness release button
6. Harness strap
7. Baby insert

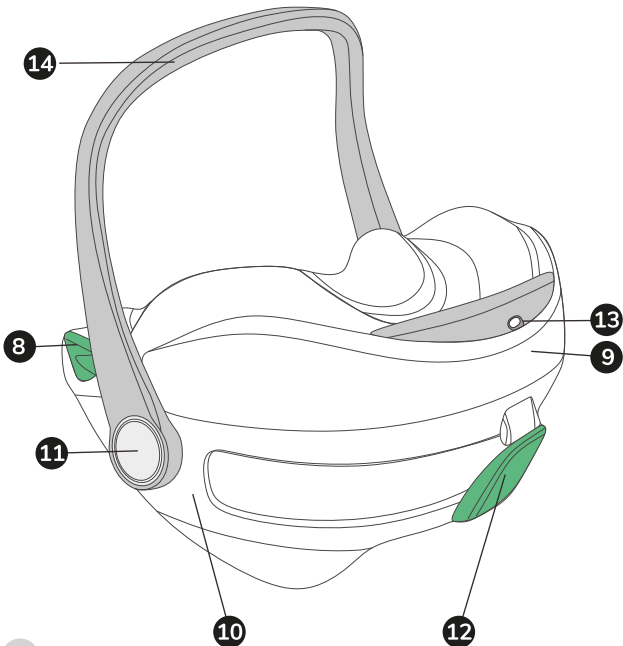

8. Lap belt guide
9. Sun shade cover
10. Seat shell
11. Handle adjuster
12. Diagonal belt guide
13. Headrest adjuster
14. Handle

USE IN THE VEHICLE

Certification



... as a child safety seat installed in a vehicle

My Babiie iSize Isofix base Child Safety Seat	Tested and certified according to ECE*R129	
	Applicable size range	Body weight
My Babiie iSize Isofix base	Height from 40cm to 87cm	Up to 13kg

*ECE = European Standard for Safety Equipment

The child safety seat has been designed, tested and certified according to the requirements of the European Standard for Child Safety Equipment (ECE R 129).

The seal of approval E (in a circle) and the approval number are located on the approval label (sticker on the child safety seat).

This approval will be invalidated if you make any modifications to the child safety seat.

Only the manufacturer is permitted to make modifications to the child safety seat.

2. Use in the vehicle

! WARNING

Never use this child restraint system in seating positions where an active airbag is installed. An active frontal airbag may cause death or seriously injury of your child in an accident. Please read the instructions carefully and keep safely for future reference.

There is an instructions compartment in the back of the child car seat for storage of the instructions manual.



You can use your child car seat as follows:

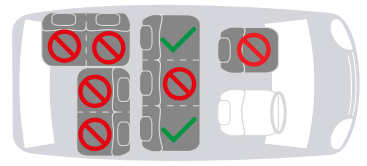

SECURING YOUR BABY

3. Securing your baby

3.1 Securing your baby using the baby insert



For the protection of your baby

The baby insert gives your baby the necessary support while he or she is still small. The baby insert is used to provide extra comfort for very small babies.

Caution! Please use the baby insert attached to this infant carrier when your baby's height is less than 75cm

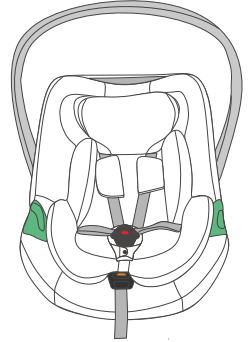

- Always secure your baby in the infant carrier using the harness.
- Never leave your baby unattended in the infant carrier when placing it on elevated surfaces (e.g. a table, nappy changing unit, etc.).
- Never allow the strap end to become caught in moving parts (e.g. automatic doors, escalators, etc.).
- **Caution!** The plastic parts of the infant carrier heat up in the sun, be aware that your baby may get burnt. Protect your baby and the infant carrier against intensive solar radiation (e.g. by putting a light cloth over the seat).
- The infant carrier requires only one seating position in the car. This advantage means, however, that your baby must be in a semi-reclined position.
- Take your baby out of the infant carrier as often as possible to relieve its spine. We recommend frequent breaks during long journeys. Even outside of the car, please avoid leaving your baby in the infant carrier for too long.

3.2 Adjusting the handle

You can engage the handle in four positions

Simultaneously press both buttons on the handle. Then whilst holding the adjuster pressed turn the handle backwards until it engages in the desired position.

A: Only use for carrying, can not be in this position when installing in the vehicle seat. **Caution!** Ensure that the handle is securely engaged before you pick up the infant carrier.

B: For placing your baby into the infant carrier.

C: For setting the infant carrier down safely outside the car.

D: Should be used when installed on the vehicle seat.

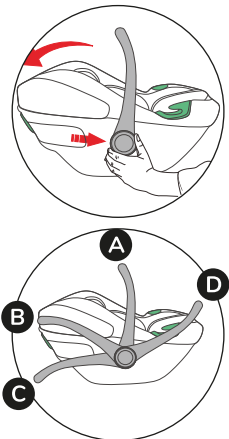

SECURING YOUR BABY

3.3 Adjusting the headrest

A correctly adjusted headrest ensures your baby's optimal posture in the infant carrier.

The headrest must be adjusted so that the shoulder straps are at the same level as your baby's shoulders or slightly above.

To adjust the height of the headrest to fit your baby:

Tilt the headrest adjuster until it disengages. Slide the headrest adjuster until the shoulder straps are at the correct height and re-engage.

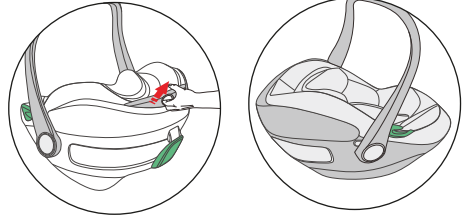

3.4 Loosening the shoulder straps

Press the harness release button and at the same time pull both shoulder straps forward.

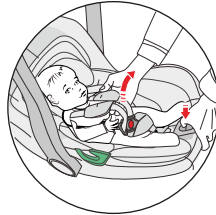

3.5 Securing your baby using the harness

- Loosen the shoulder straps.
- Open the harness buckle (press the red release button).

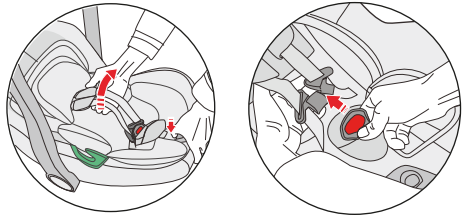

- Place your baby into the infant carrier.
- Put the shoulder straps over the shoulders of your baby, then put the buckle tongues together and engage in the harness buckle with an audible "click".

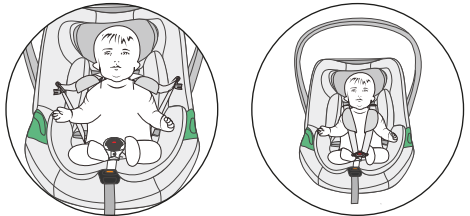

Caution! Do not twist or interchange the shoulder straps.

SECURING YOUR BABY

3.6 Tightening the harness

Pull the strap end.

Caution! Pull the strap end straight towards you, not upwards or downwards.

Please pay attention to the strap end whilst travelling (especially outside the car) it should always be attached to the cover.

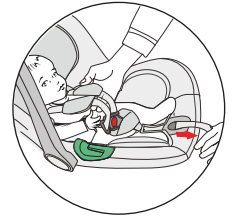

3.7 Checklist to ensure that your baby is buckle up correctly



For the safety of your baby, please check that...

- The shoulder straps of the infant carrier are comfortable but are a FIRM fit around your child.
- The shoulder straps are adjusted correctly.
- The shoulder straps are not twisted.
- The buckle tongues are engaged in the harness buckle.

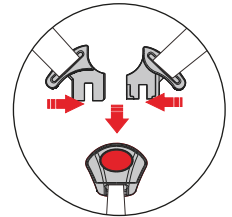

INSTALLATION IN THE VEHICLE

4.1 Installation in the vehicle



Please do not leave your child unattended in the child safety seat in the vehicle.



For the protection of all vehicle occupants

In the case of an emergency stop or an accident unsecured persons or objects may cause injury to other vehicle occupants. Please always check that ...

- The backrests of the vehicle seats are locked (i.e. that a foldable rear seat bench latch is engaged).
- All heavy or sharp-edged objects in the vehicle (e.g. on the parcel shelf) are secured.
- All persons in the vehicle have their seat belts fastened.
- The child safety seat is always secured when it is in the vehicle, even if no child is being transported.

To protect your vehicle

Some vehicle seat covers of sensitive materials (e.g. velour, leather, etc.) may develop wear marks when child seats are used. This can be avoided by placing a blanket or towel under the child seat.



The baby insert is only suitable for infants with height from 40 to 75CM . if your child has height more than 75cm please take out the baby insert .

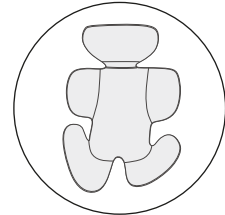

4.2 Installation instruction for STATURE 40- 87 cm, Rearward facing,

ISOFIX + Support Leg+ harness.

Unfold the support leg until it locks in place.
Press the ISOFIX release button to slide the ISOFIX connectors to the end.

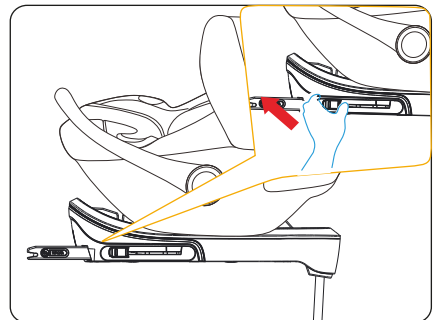

INSTALLATION IN THE VEHICLE

Caution: Please only move to next step when ISOFIX has been slid to the end with the red indicators showing.

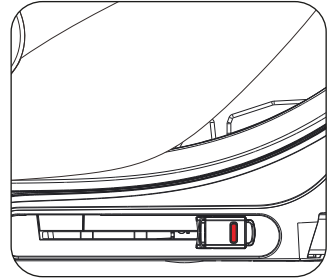

Push the ISOFIX connectors directly into the anchorages until you hear an audible "click" sound

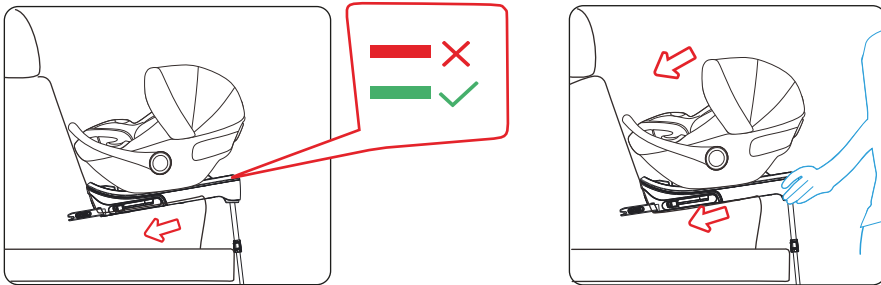

Ensure that the handle is in its upper position D.

Grasp the seat base to check the seat is fastened tightly or shakes, meanwhile observe the ISOFIX red/green indicator. If the seat shakes and the ISOFIX connectors are pulled out, please repeat the above steps and install it again.

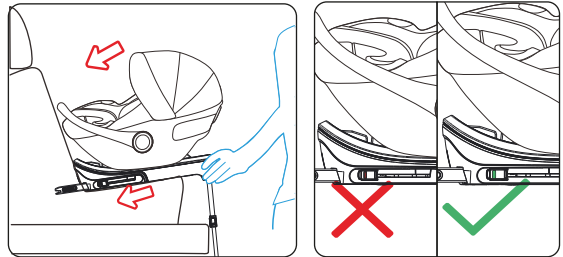

Squeeze the support leg adjusting button, pull out the support leg until it rests firmly on the floor. Observe the ISOFIX red/green indicator to confirm the installation status.

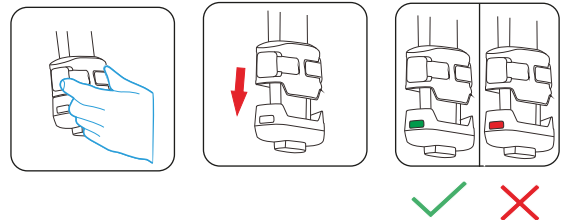

WARNING!

Do not install the car seat if there is a storage compartment below the support leg.

INSTALLATION IN THE VEHICLE

5.1 Installation in the vehicle using the vehicle's seat belt (Not using the Isofix base)

To secure the infant carrier using the 3-point belt of your vehicle proceed as follows:

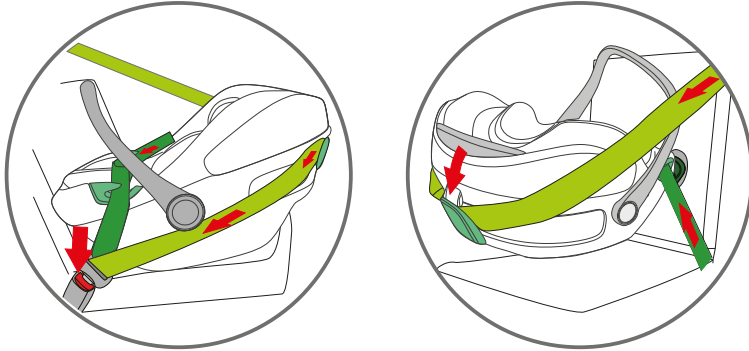

Place the infant carrier rearward facing on the vehicle seat (baby is facing backwards). In certain cases it is possible that the infant carrier does not rest securely or is inclined too steeply on the vehicle seat.

Ensure that the handle is in its upper position D.

Pull out the vehicle seat belt and place it across the infant carrier.

Engage the buckle tongue in the vehicle seat buckle.

Place the lap belt section in the green belt guides on both sides of the infant carrier.

Caution! Do not twist the belt.

Tighten the lap belt section by pulling the diagonal belt section.

Pull the diagonal seat belt section behind the top end of the infant carrier.

Caution! Do not twist the belt.

! For the safety of your baby, please check that:

- The infant carrier is installed rearward facing.
- The infant carrier is only installed on the front passenger seat if no front airbag can strike the infant carrier.
- The infant carrier is only secured using a 3-point belt.
- The lap belt section runs through both green belt guides on the infant carrier.
- The diagonal belt section runs through the light green belt guides on the infant carrier.
- The vehicle seat belt is tightened up and not twisted.

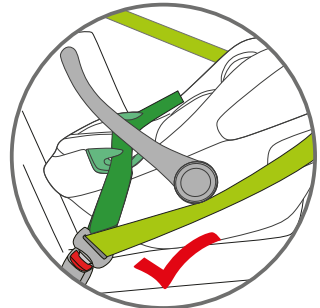

FITTING THE SUNSHADE

6. Pull the head plate to expand/Fold the canopy.

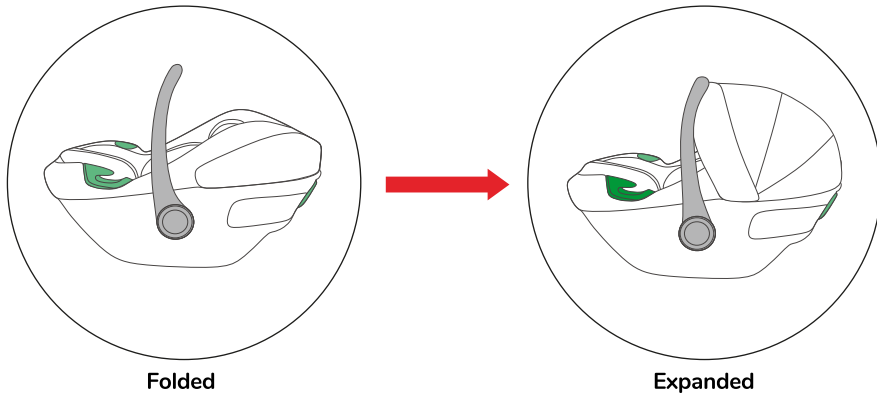

PRODUCT CARE



Follow these instructions for protective product care

- In an accident at a collision speed above 10 km/h the child safety seat could suffer damage which is not necessarily obvious.
- In such cases it is extremely important that you replace the child seat. Please dispose of it properly.
- Regularly check all important parts for damage.
- Ensure the correct operation of all mechanical components.
- To prevent damage or breakage, ensure that the child seat does not become jammed in the car door, seat runners, etc.
- Should the child seat be damaged (for example after dropping it) it must be inspected by the manufacturer.

Care for the harness buckle

The function of the harness buckle is important for the safety of your child. Malfunctions of the harness buckle are mostly attributable to accumulations of dirt and dust.

PRODUCT CARE

Removing the fabrics to clean

Undo the button on the side part of the cover.

Undo button on the main cover.

Press the harness release button and at the same time pull both shoulder straps forward.

Undo the button on the main cover and the should pad.

Take off the fabric cover and wash it.

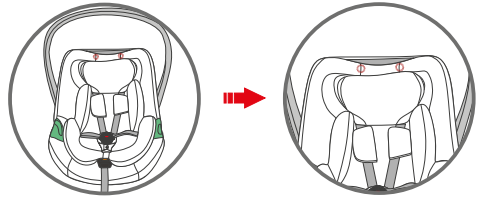
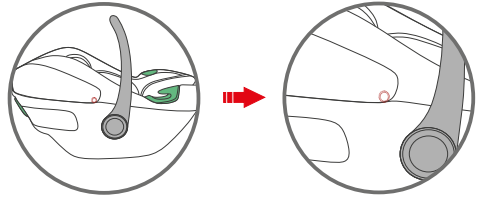

Refitting the fabric cover

To refit the cover on the seat just hook up the elastic loops to the hooks and fit back the headrest cover.

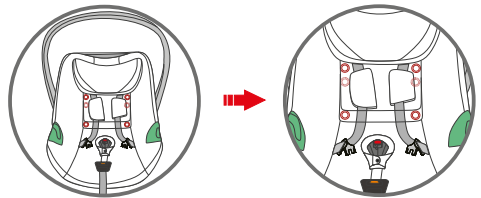
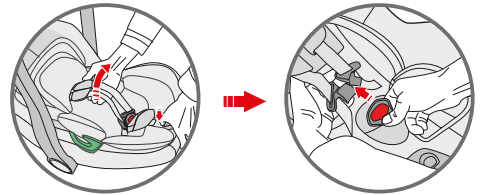

CLEANING

Please be sure to use only original My Babiie replacement seat covers, as the seat cover is important to the proper functioning of the system. Replacement seat covers are available from My Babiie.



The child seat must not be used without the seat cover.

- The cover can be removed and hand washed at 30°C with a mild detergent. Please observe the instructions on the washing label of the cover. The colours of the cover may fade if washed at more than 30°C. Never tumble dry in an electric clothes dryer (the fabric may separate from the padding).
- The plastic parts can be cleaned using soapy water. Do not use harsh cleaning agents (such as solvents).
- The harness can be removed and washed in lukewarm soapy water.

Caution! Never remove the buckle tongues from the straps.

WARRANTY

For this child seat we provide a 1 year warranty against manufacturing or material defects. The warranty period is effective from the day of purchase.

The Warranty does not cover:

- Natural signs of wear and damage resulting from excessive stress.
- Damage resulting from inappropriate or improper use.

What is covered by the Warranty?

Fabric: All of our fabrics meet very high requirements with regards to colour fastness when exposed to UV radiation. Nevertheless, all fabrics fade when exposed to UV radiation. This is not a material defect, but rather a normal sign of wear which is not covered by the Warranty.

Buckle: Buckle malfunction is often due to accumulations of dirt and dust which may stop it from working properly. If this happens, please firstly check if you can clean by yourself without damaging the installation. If not, please contact the aftersale service. Please contact your retailer directly in the event of a warranty claim. He or she will give you the advice and support you need. When processing claims, product-specific depreciation rates will be applied. Please refer to our General Terms and Conditions which are available from your retailer.

PUSHCHAIR DO'S & DON'TS



Do use your brakes!

Ensure the parking brake is engaged during the loading and unloading of children & when the pushchair is stationary.

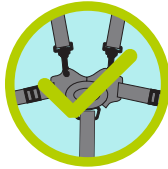

Do always use the restraint system!

Ensure that the child restraint system is correctly fitted at all times.



Do keep your pushchair clean and dirt free.

Use a clean white cloth, warm water and a mild detergent to keep your pushchair clean.



Do always keep two hands on the handles when pushing.

You could lose control of your pushchair if not steering with both hands.



Do follow manufacturers instructions when assembling and using your pushchair.

For safety, please refer to our instruction manuals or contact customer support if you're unsure.



Don't use your pushchair up and down stairs!

Don't use your pushchair up or down stairs or to bump kerbs.



Don't hang bags off the handles!

Bags and other items should not be hung from the handles as this can affect the stability of the pushchair.



Don't run or skate with your pushchair!

Our products are not suitable for running or skating.



Don't carry the stroller with baby inside!

Our pushchairs are not designed to be carried with your baby inside them.



Don't put hot drinks in the cup holder.

Hot drinks burn and can easily spill from the bottle holder.



Don't jetwash your pushchair.

Some jet washers are very powerful and could damage parts of your pushchair!



Don't leave your child un-attended in their pushchair.

Always keep your child and pushchair in view to avoid accidents.



Don't treat your pushchair like a trolley.

Don't load your pushchair up with all your shopping as they are not built for this purpose and could cause damage.



Don't use your pushchair as a bumper cart!

Damage can easily occur if your pushchair is knocked into other things.



Don't smoke around your pushchair.

We wouldn't want your pushchair or little one getting hurt or damaged!



Don't leave your pushchair unattended on extreme gradients.

Even with your brakes on your pushchair is at risk from tipping or sliding on extreme gradients!



Don't sit in the pushchair unless the user is under the guideline weight.

Our pushchairs are designed to hold a maximum weight. If exceeded this will cause damage!



Do enjoy your My Babie product!

Go out and have fun adventures with your little one!

MyBabiie®

For little people who dream big

REGISTER YOUR PRODUCT AT

www.mybabiie.com/warranties

**In the first instance of needing assistance please
contact your original place of purchase.**

This product qualifies for 12 month warranty
when registered through our website

STAY CONNECTED!



My Babiie



@MyBabiieOfficial



My Babiie



@MyBabiie



@mybabiie_official

My Babiie Ltd
Paddock Wood, Kent, TN12 6EN

My Babiie EU
Generaal Vetterstraat 76A, 1059 BW Amsterdam, The Netherlands